

**Discreet  
Acoustics  
Modular PLUS  
Series**

---

**AKG**<sup>®</sup>  
by HARMAN

## Table of Contents

<b>1</b>	<b>Safety and Environment.....</b>	<b>3</b>
	Safety.....	3
	Environment .....	3
<b>2</b>	<b>Description.....</b>	<b>4</b>
	Introduction .....	4
<b>3</b>	<b>Microphone Applications .....</b>	<b>5</b>
<b>4</b>	<b>Installation and Connection .....</b>	<b>6</b>
	Capsule Modules .....	6
<b>5</b>	<b>Modules falling into Place.....</b>	<b>7</b>
	CK49 .....	7
	CK43 .....	8
	CK41 .....	9
	GN15,30,50 M .....	10
	GN155 M .....	11
	HM1000 M.....	12
	PAESP M.....	13
	PAE5 M .....	14
	PAE M.....	15
<b>6</b>	<b>Mounting Material, Cables and Accessories.....</b>	<b>16</b>
	Mounting Material .....	16
	MF M .....	16
	H600.....	16
	H500.....	17
	ST45 (+SA60).....	17
	SA60.....	17
	Cables.....	18
	MK150 M.....	18
	MK150 ML .....	18
	Accessories .....	18
	UWA9 M.....	18
	W40 M.....	18
<b>7</b>	<b>Application Examples .....</b>	<b>19</b>
<b>8</b>	<b>Dimensional Drawings.....</b>	<b>22</b>
<b>9</b>	<b>Comparison Chart .....</b>	<b>24</b>
<b>10</b>	<b>Notes.....</b>	<b>25</b>



# 1 Safety and Environment

## Safety

- Do not expose the equipment to direct sunlight, excessive dust, moisture, rain, mechanical vibrations, or shock.
- Do not spill any liquids on the equipment or allow objects to fall inside through the ventilation slots.
- The equipment must only be used in dry rooms.
- The equipment must only be opened, serviced, and repaired by authorised personnel. The equipment contains no user-serviceable parts.
- If any solid object or liquid should get into the equipment, shut down the system immediately.
- Do not place the equipment near heat sources such as radiators, heating ducts, amplifiers, etc. and do not expose it to direct sunlight, excessive dust, moisture, rain, mechanical vibrations, or shock.
- To avoid hum or interference, route all audio lines, particularly those connected to the microphone inputs, away from power lines of any type. If you use cable ducts, be sure to use separate ducts for the audio lines.
- Clean the equipment with a moistened (not wet) cloth only. Be sure to disconnect the AC adapter from the power outlet before cleaning the equipment. Never use caustic or scouring cleaners or cleaning products containing alcohol or solvents since these may damage the enamel and plastic parts.
- Only use the equipment for the applications described in this manual. AKG cannot accept any liability for damages resulting from improper handling or misuse.
- Electrostatic charges may damage electronic circuits. Therefore, be sure to touch a bare, grounded metal part to discharge any static charge that may have built up on your body, before touching any electronic circuit board.

## Environment

- The packaging of the equipment is recyclable. To dispose of the packaging, make sure to use a collection/recycling system provided for that purpose and observe local legislation relating to waste disposal and recycling.



## 2 Description

### Introduction

Gooseneck microphones are often overlooked, but they are high-performing electro-acoustic devices which carry out difficult work discreetly and reliably. They have to function flawlessly in demanding situations with very different, often inexperienced speakers. Yet at the same time they have to deliver perfect speech clarity. AKG Discreet Acoustics Modular Series microphones have been in continuous use at international meetings, conferences and summits, in parliaments and in churches for decades and are recognized as an industry standard.

Depending on the specific purpose, special requirements can often only be fulfilled by modular systems. The Discreet Acoustics Modular Series is renowned worldwide for its durability, reliability and flexibility.

**Modularity:** The AKG Discreet Acoustics Modular Series offers a choice of interchangeable capsule modules with different polar patterns and frequency responses. A wide range of goosenecks and installation modules is also available. In addition, there are special-purpose modules for applications not covered by any other available products. They can be used in conjunction with wireless systems as well as with AKG's digital conference system CS5. Their rapidly changeable capsules not only allow optimal adaptation to different rooms and speakers but also enable quick microphone capsule exchange if, in exceptional circumstances, anything should go wrong.

**Reliability:** A wide range of features minimizes the risk of operating errors, material fatigue, or signal dropouts. The LED ring and self-cleaning gold-plated contacts for the threaded connections are standard, as are anti-twist cables and a switchable bass roll-off filter.

**Low profile:** The extremely compact design and matte finish underscore the inconspicuous appearance of the Discreet Acoustics Modular Series. The low-profile installation modules ensure quick setup and takedown of all versions of the series. Excellent response and extremely good intelligibility make the Discreet Acoustics Modular Series the first choice whenever quality and reliability have top priority. Small wonder that decision makers all over the world appreciate AKG as a professional partner. Targeting the premier league of the installation market, the further development of the Discreet Acoustics Modular Plus Series means that literally everything became even better. Its slimmer design and improved audio quality are a perfect fit in the high-end market. An additional interface between gooseneck module and phantom power adapter means added modularity and flexibility, resulting in significant advantages throughout the distribution chain, where fewer variations need to be stocked. Moreover, installers will receive the required products faster and the added modularity and new accessories will enable solutions for applications never before dreamed of. With just a few components on hand, the Discreet Acoustics Modular Series allows a nearly unlimited number of combinations.

The Discreet Acoustics Modular Plus Series is the logical evolution of AKG's Modular Series. It brilliantly fulfills all essential requirements for professional sound system applications. It is quick, reliable and available – and it works perfectly for you!



### 3 Microphone Applications

Note that both the maximum working distance and the area covered by the microphone depend on the pickup angle. The smaller the pickup angle (hypercardioid), the longer the maximum distance between the talker and the microphone and the smaller the area covered by the microphone.

Whether an omnidirectional, cardioid, or hypercardioid capsule will give the best results therefore depends on the specific application situation.



NOTE

#### OMNIDIRECTIONAL CAPSULES

Omnidirectional capsules are primarily suited for recording use.

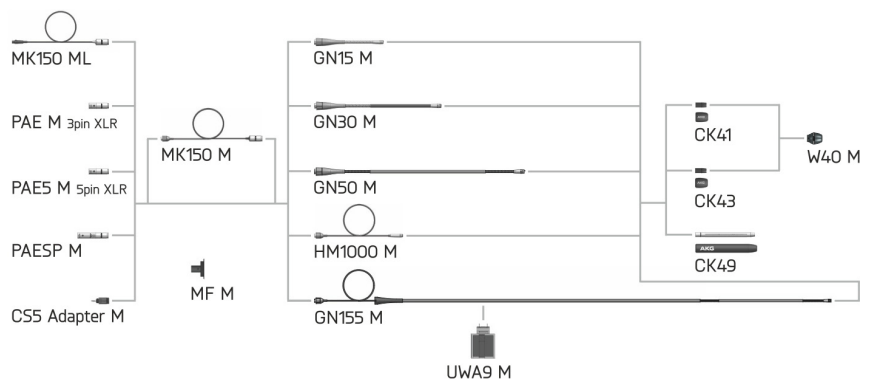

## 4 Installation and Connection

### Capsule Modules

All Discreet Acoustics Modular Capsule Modules are condenser microphones and therefore require a power supply (phantom power). The Installation Modules have been designed for connection to microphone inputs with 9 to 52 V phantom power.

- 1) Screw the Capsule Module onto the Installation Module. The screw thread is relatively fine and therefore very smooth-running. Make sure not to tilt the capsule when placing it on the Installation Module thread because this would damage the thread.
- 2) To lock the capsule, use a single drop of commercial minimum-tack screw locking adhesive that allows you to unscrew the capsule later if needed.
- 3) For better visibility put the LED-Ring Expansion between the Installation Module and the Microphone Capsule.  
(The LED-Ring Expansion is enclosed to the Installation Module.)



NOTE

#### UNWANTED NOISE

Before replacing a Capsule Module, be sure to switch your sound system OFF in order to prevent unwanted noise.

Choose the Phantom Power Adapter according to your application.  
*PAESP M* (page 13), *PAE5 M* (page 14) or *PAE M* (page 15).



## 5 Modules falling into Place

CK49



Reference Shotgun Condenser Capsule

### Lectern and Ambo

#### Presentation

#### Theater

The CK49 is a reference condenser capsule with an 80° pickup angle and clean off-axis response. It is an ideal tool for inexperienced speakers; when people talk into the microphone from greater distances it focuses on the voice, and when they talk into it from very short distances it reduces pop-noise. Its special capsule is a further development of the legendary CK47 capsule. Like its predecessor, it is designed using AKG's unique staple technology for brilliant studio-quality audio performance.

The CK49 capsule is integrated into an extremely slim and rugged metal housing. It fits all gooseneck modules of the Modular Plus Series as well as the HM1000 M hanging module. To prevent contact problems the capsule is equipped with large-area, self-cleaning, gold-plated contacts with deep threads to prevent misalignment and ensure extra-long life. The CK49 comes complete with a windscreen that efficiently reduces wind and pop noise.

- **Tight, hypercardioid polar pattern**  
eliminates noise from the sides
- **80° pickup angle**  
for inexperienced speakers and greater distances
- **Sophisticated staple capsule technology**  
for studio-quality audio performance
- **Highly reliable capsule contacts**  
prevent contact problems and ensure extra-long life
- **Highly efficient windscreen**  
reduces wind and pop noise

#### Included accessories:

Windscreen

Item Number:

CK49

3165Z00030

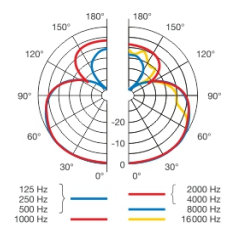
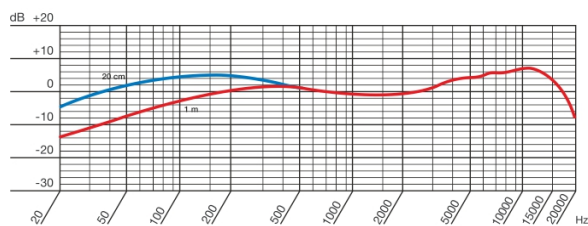

CK43



Reference Condenser Capsule

**Theater and onstage miking**  
**Houses of worship**  
**Parliaments**

The CK43 is a reference supercardioid condenser capsule with studio-quality audio performance. Due to the narrow 95° pickup angle, the supercardioid polar pattern is a good choice for all situations when unwanted noise typically arrives from the sides (e.g. in places of worship) and where people talk into the microphone from greater distances.

The CK43 capsule is integrated into an extremely slim and rugged metal housing. It fits any mounting module of the Modular Plus Series. To prevent contact problems the capsule is equipped with large-area, self-cleaning, gold-plated contacts with deep threads, which prevent misalignment and ensure extra-long life. The CK43 comes complete with a highly efficient windscreen.

- **Supercardioid polar pattern**  
eliminates noise from the sides
- **95° pickup angle**  
perfect when people talk from greater distances
- **Sophisticated staple capsule technology**  
for studio-quality audio performance
- **Highly reliable capsule contacts**  
prevent contact problems and ensure extra-long life
- **Wide frequency range**  
for a speech-optimized audio performance

**Included accessories:** Windscreen  
**Optional accessories:** W40 M Wire-mesh windscreen  
**Item Number:** CK43 3165Z00020

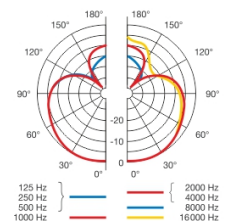
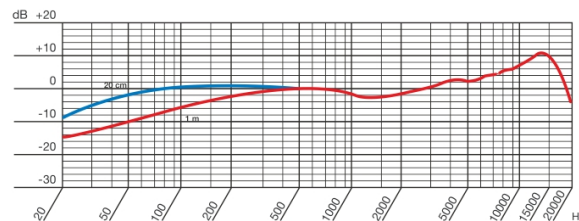



CK41



Reference Condenser Capsule

**Round table discussions**  
**Press conference**  
**Videoconference**

The CK41 is a reference condenser capsule with a wide cardioid polar pattern and a speech optimized frequency response. The cardioid is the most popular polar pattern, since it can be used almost universally. The 125° pickup angle is especially suited for inexperienced or very vivacious speakers as well as applications where more than one person uses the microphone in turn.

The CK41 capsule is integrated into an extremely slim and rugged metal housing. It fits any mounting module of the Modular Plus Series. To prevent contact problems, the capsule is equipped with large-area, self-cleaning, gold-plated contacts with deep threads to prevent misalignment and ensure extra-long life. The CK41 comes complete with a highly efficient windscreen.

- **Cardioid polar pattern**  
eliminates noise from the rear side
- **125° pickup angle**  
for inexperienced or very vivacious speakers
- **Sophisticated staple capsule technology**  
for studio-quality audio performance
- **Highly reliable capsule contacts**  
prevent contact problems and ensure extra-long life
- **Wide frequency range**  
for a speech-optimized audio performance

**Included accessories:** Windscreen  
**Optional accessories:** W40 M Wire-mesh windscreen  
**Item Number:** CK41 3165Z00010

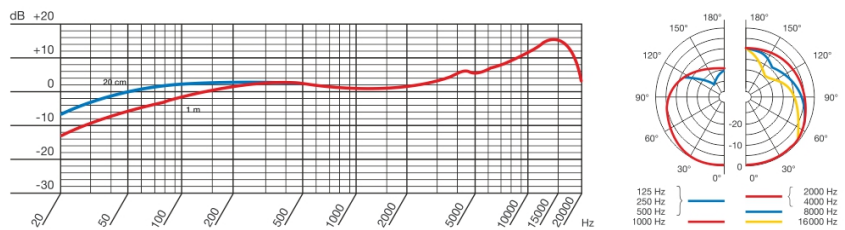

GN15, 30, 50 M



Reference Gooseneck Module

**Discussion systems**  
**Lectern and Altars**  
**Press conferences**

The Modular Plus Series premium gooseneck modules for permanent and mobile installation are available in three different lengths: 165 mm (6.5 in), 300 mm (11.8 in) or 500 mm (19.7 in). The extremely slim and rugged gooseneck modules feature an LED ring which indicates whether the phantom power is on or off. A special light-ring expander comes with every Modular Plus gooseneck module to improve the visibility of the LED ring if necessary.

For quick setup and maximum flexibility all gooseneck modules come with a Modular Plus Series system connector. This high quality connector with gold-plated contacts reliably fits all available phantom power modules. The gooseneck module is compatible with all Modular Plus Series capsules, CK41, CK43, CK49 via self-cleaning contacts. Their extremely deep thread groove prevents misalignment and ensures a long useful life of all Modular Plus components.

- **Extremely rugged gooseneck construction**  
for an extra-long life of reliability and stability
- **Highly reliable contacts for capsule modules**  
prevent contact problems and ensure extra-long life
- **Integrated switchable LED ring**  
to show system status
- **Integrated system connector**  
helps saving costs in stock keeping
- **Broad assortment of mounting accessories available**  
for quick and hassle-free installation

<b>Included accessories:</b>	LED ring expander	
<b>Item Number:</b>		
GN15 M	3165H00080	165 mm (6.5 in)
GN30 M	3165H00090	300 mm (11.8 in)
GN50 M	3165H00100	500 mm (19.7 in)



GN155 M



Reference Gooseneck Floor Stand

**Houses of worship**  
**Choir recording**  
**Presentation**

The GN155 M is a reference 1490 mm (58.7 in) gooseneck module with a heavy, shock-mounted floor stand. It works perfectly as a stand-alone unit on stages or placed in front of a lectern as well as for pickup of violins and other instruments. An integrated light-ring shows the status of the microphone at a glance. A special light-ring expander comes with every Modular Plus gooseneck module to improve the visibility of the LED ring if needed.

The GN155 M has an attached 10 m (33 ft) cable with a Modular Plus Series system connector, fitting all available phantom power modules. The gooseneck module is compatible with all Modular Plus Series capsules, CK41, CK43, CK49 via highly reliable contacts.

- **Elegant, low profile floor stand**  
fitting ALL environments
- **Integrated switchable LED ring**  
to show system status
- **Extremely rugged gooseneck construction**  
for an extra-long life of reliability and stability
- **Quick-absorbing rubber shock mount**  
for optimum suppression of structure-borne noise
- **Highly reliable contacts for capsule modules**  
prevent contact problems and ensure extra-long life

**Included accessories:** LED ring expander, Floor stand  
**Item Number:** GN155 M 3165Z00240

**GN155 M Installation Module**

- 1) Screw the desired Capsule Module onto the Installation Module.
- 2) Screw the Installation Module onto the supplied floor stand.
- 3) Screw one of the three available phantom power adapters or MK150 M / MK150 ML onto the cable end.
- 4) Connect the phantom power adapter to a microphone input with phantom power.



HM1000 M

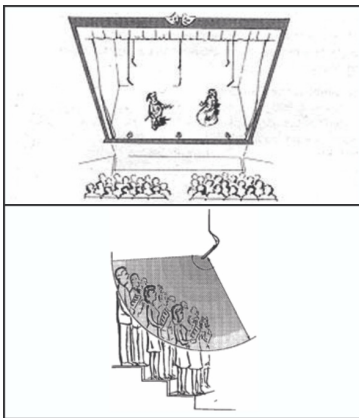

Reference Hanging Module

**Theater and onstage miking**  
**Houses of worship**  
**Broadcast studio**

The HM1000 M is a reference hanging module compatible with all capsules of the Modular Plus Series (CK41, CK43 and CK49). It is used to fly microphones from the ceiling to record music or speech in places of worship or conference rooms, or on theater stages. An integrated switchable light-ring shows the status of the microphone at a glance. A special light-ring expander comes with every Modular Plus hanging module to improve the visibility of the LED ring if necessary.

The HM1000 M provides a 10 m (33 ft) special cable that will not tend to twist, even if the temperature varies. A spring steel hanging clamp for precise microphone alignment is also included in the package. The integrated system connector fits all available phantom power modules of the Modular Plus Series.

- **Twist-free 10m cable included**  
to fix and secure the designated mic position
- **Highly reliable contacts for capsule modules**  
prevent contact problems and ensure extra-long life
- **Spring clamp for vertical adjustment**  
allows quick and hassle-free installation
- **Integrated switchable LED ring indicator**  
for full control of the installation status
- **Ingenious system connector interface**  
adapter adds flexibility to all mounting modules

**Included accessories:** Hanging clamp, LED ring expander  
**Item Number:** HM1000 M 3165H00250

**HM1000 M Hanging Module**

- 1) Prior to installing the HM1000 M, straighten the cable by carefully pulling it through your fingers. Make sure not to buckle or twist the cable.
- 2) Fasten a hook to the ceiling, use an existing hook, or stretch a line across the hall.
- 3) Pass the cable through the hook or over the line so that it will hang at the desired height.
- 4) Fix the cable in place with electrician's tape.



**RISK OF DAMAGE!**

Do not tie a knot into the cable to hang it on the hook.

ATTENTION

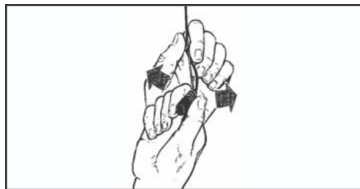

- 5) Hold the cable with one hand and turn the microphone carefully into the desired position. To activate the bass cut, refer to *PAESP M* (page 13), *PAE5 M* (page 14) or *PAE M* (page 15).

**Steadying the microphone**

To keep the microphone steady even in a draft,

- 1) Stretch a suitable length of fishing line horizontally across the room, passing the fishing line through the eye on the HM1000 M.
- 2) Fix the fishing line to two opposite walls so as to create just enough downward pull to steady the microphone laterally.



PAESP M



Reference Programmable Powering Module

**Small discussion systems**

**Press conference**

**Lectern**

The Modular Plus Series PAESP M is a programmable phantom power module for fixed and mobile installation. With its wide voltage range the module will fit most available microphone mixers. It comes with a unique BCD (binary coded decimal) switch to recall one of the operating modes. Several functions can be adjusted, e.g. bass roll off, LED ring mode (on, off, follow mic function) as well as the mic switch mode (push to mute, push to talk, push on – push off).

The PAESP M features a completely noiseless microphone switch. Rather than actually disconnecting the signal, it reduces the level by 26 dB, thus avoiding the irritating crackling sound when phantom powering is interrupted. The switch is inconspicuously placed but easily accessible for simple handling even by inexperienced talkers. The integrated system connector with gold-plated contacts securely fits all available mounting modules of the Modular Plus Series.

- **Programmable on/mute/off switch**  
offers noiseless switching
- **Selectable operating modes**  
for switchable bass roll off and light-ring function
- **RFi Shield technology**  
provides high immunity to radio-frequency interference
- **Accepts 9-52 V input**  
for almost any available mixer inputs
- **Feeds all Modular Plus Series capsules**  
for highest flexibility

Item Number: PAESP M 3165H00170

PAESP M



Pos.	LED	Basscut	Switch
0	off	off	on/off
1	off	off	ptt
2	off	off	ptm
3	off	off	–
4	off	on	on/off
5	off	on	ptt
6	off	on	ptm
7	off	on	–
8	on	off	on/off
9	on	off	ptt
A	on	off	ptm
B	on	off	–
C	on	on	on/off
D	on	on	ptt
E	on	on	ptm
F	on	on	–

on/off toggle  
 ptt push to talk  
 ptm push to mute  
 – without any function

Disconnect XLR-plug before changing settings!



PAE5 M



Reference Power Module To Combine With Automixers

**Podium discussions**  
**Houses of worship**  
**Broadcast stations**

The PAE5 M reference phantom power module for fixed and mobile installation provides a five-pin XLR connector that allows the audio signal and the control voltage for a LED ring to be fed separately. Thus, the LED ring can be activated remotely by a 9-52 V logic output from any automatic mixer to show the “mic on” status. With its wide voltage range the module will fit most available microphone mixers.

The PAE5 M features a bass roll off for reduction of structure-borne noise. Its integrated system connector with gold-plated contacts securely fits all available gooseneck modules of the Modular Plus Series as well as the HM1000 M hanging module.

- **Extra feeding of LED ring to show Mic status**  
for use with automixers including logic outputs
- **Switchable bass rolloff**  
for reduction of body noise and proximity effect
- **Highly reliable contacts to mounting modules**  
prevent contact problems and ensure extra-long life
- **RFi Shield technology**  
provides high immunity to radio-frequency interference
- **Feeds all Modular Plus Series capsules**  
for highest flexibility

**Item Number:** PAE5 M 3165H00160

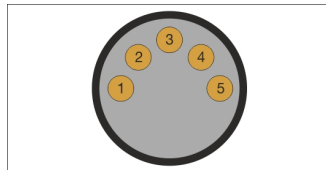

**Added Connectivity: 5-pin powering**

The 5-pin XLR connector allows the audio signal and control voltage for the LED ring to be fed separately. Connector pin out:

1: Audio ground, 2: LED ring +, 3: Audio in phase, 4: LED ring -, 5: Audio return

**PAE5 M**

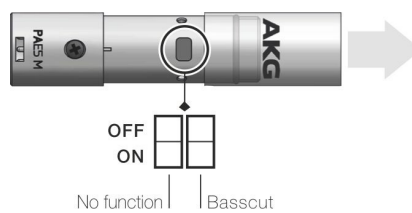

PAE M



Reference Powering Module

**Houses of worship**  
**Conferencing**  
**Theaters**

The PAE M reference phantom power module for fixed and mobile installation provides a gold-plated three-pin XLR connector. With its wide voltage range the module will fit most available microphone mixers. The module also features a 250 Hz bass roll off for reduction of structure-borne noise.

The PAE M comes with an integrated system connector with gold-plated contacts. This unique connection securely fits all available gooseneck modules of the Modular Plus Series as well as the HM1000 M hanging module.

- **Feeds all Modular Plus Series capsules**  
for highest flexibility
- **RFi Shield technology**  
provides high immunity to radio-frequency interference
- **Accepts 9-52 V input**  
for almost any available mixer inputs
- **Switchable bass roll off**  
for reduction of body noise and proximity effect
- **Highly reliable contacts to mounting modules**  
prevent contact problems and ensure extra-long life

Item Number: PAE M 3165H00150

PAE M

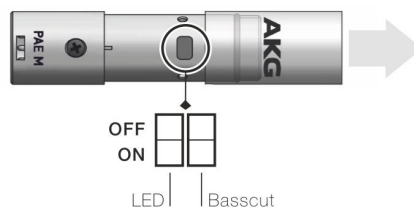

## 6 Mounting Material, Cables and Accessories

### Mounting Material

To mount your gooseneck please choose one of the following accessories according to your needs.



#### MF M

The MF M is a flush-mount module that efficiently reduces body noise from tables. Its slim design can integrate each powering module of the Modular Plus Series and allows the microphones to be detached when not in use. A special blind cap seals the connector outlet, leaving an attractive flush interface in the table and simultaneously sealing the connector to protect it against dust.

**Item Number:** MF M 3165H00220

- 1) Cut a hole of 50 mm (2 in) into the table.
- 2) Insert the MF M from above.
- 3) Integrate either PAE M or PAE5 M from below and secure the power adapter with included screws.



#### H600

The H600 is a flush-mount module that offers optimum attenuation of structure-borne noise. Its two different diameters offer highly flexible mounting options. The H600 offers a unique theft-proof lock and is ideal for use with the PAESP M (powering module with programmable switch) in combination with GN15 M and GN30 M goosenecks modules. Required mounting hole: 53 mm (2.1 in).

**Item Number:** H600 2426X00030

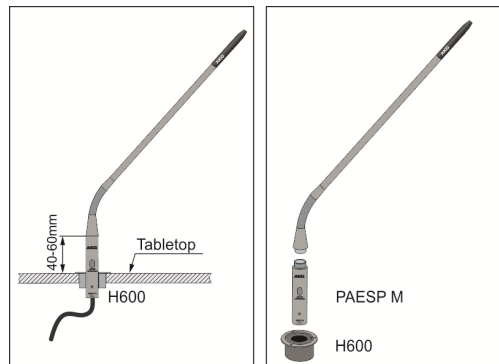





**H500**

The H500 is a shock mount for gooseneck microphones. It is the most cost-efficient solution, ideal for easy installation and takedown of sound systems. The construction is designed to hold even longer goosenecks such as the GN50 M. The H500 requires a mounting hole of 50 mm (2 in).

**Item Number:** H500 6000H01900

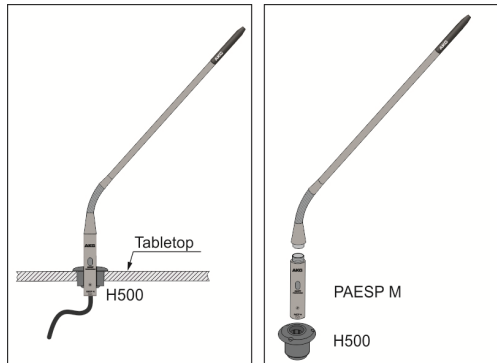

**ST45 (+SA60)**

The ST45 is a reference table stand for easiest installation and takedown of mobile sound systems. It is made of one solid piece of metal which gives it a firm stand on every table. The massive base plate and special shock-absorbing rubber feet effectively eliminate footfall noise. The ST45 table stand can be teamed up with the SA60 stand adapter for use with all Discreet Acoustics Modular Plus Series powering modules.

**Item Number:** ST45 6000H03080

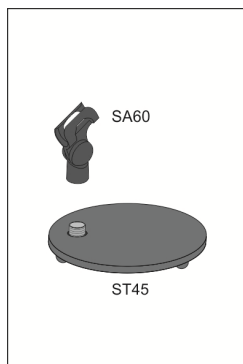

**SA60**

The SA60 is a professional stand adapter for use with straight-shaft microphones. It perfectly fits all Modular Plus powering modules and is compatible with the ST45 table stand.

**Item Number:** SA60 6000H60010



### Cables



#### MK150 M

The MK150 M is a reference extension cable for fixed and mobile installations. The cable is equipped with the Modular Plus system connector and excellently fits all mounting and powering modules. The metal housing, gold-plated contacts and deep, rugged thread prevent contact problems and ensure extra-long life. The MK150 M comes with a cable length of 1,5 m (5 ft).

**Item Number:** MK150 M 3165H00260



#### MK150 ML

The MK150 ML is a reference connection cable to combine microphones of the Modular Plus Series with any AKG bodypack transmitter (except DPT70). It enables all Modular Plus microphones to be operated wirelessly. One side of the cable is equipped with the unique Modular Plus system connector, fitting all mounting modules of the series. The other side of the cable ends in a professional 3-pin mini XLR connector. At 1,5 m (5 ft) the cable is long enough to reach a safe point in a mobile lectern table and short enough to be inconspicuous on the GN155 M.

**Item Number:** MK150 ML 3165H00270

Does not work with DPT70.

### Accessories



#### UWA9 M

The UWA9 M is a holder for wireless body-pack transmitters. It fits perfectly on the GN155 M floor stand gooseneck module. In combination with the MK150 ML it creates a wireless floor stand microphone for presentations or for choir and instrumental recording. The rugged metal plate is covered with foam to prevent scratching the transmitter housing. A universal Velcro strip is used to hold any AKG wireless body-pack transmitter.

**Item Number:** UWA9 M 3165H00280



#### W40 M

The W40 M is a reference windscreen with the highest performance in its class. Two layers of mesh and a combination of foam reduce wind and pop noise to a minimum. Its rugged wire-mesh grill securely protects the microphone even under rough day-to-day usage. The W40 M is compatible with the CK41 and CK43 capsules from the Modular Plus Series.

**Item Number:** W40 M 3165H00290



## 7 Application Examples



**STANDARD WINDSCREEN**

efficiently reduces wind and pop noise

**CK43 REFERENCE SUPERCARDIOID CONDENSER CAPSULE**

perfect when people talk from greater distances

**LIGHT RING EXPANDER**

for improved visibility of the mic's On/Off status

**GN15 M GOOSENECK MODULE**

unobtrusive and discreet

**H600 FLUSH SHOCK MOUNT MODULE**

high-damping rubber for efficient body noise suppression

**PAE 5 M PHANTOM POWER MODULE**

ideal for combination with automatic microphone mixers



**CK41 REFERENCE CARDIOID CONDENSER CAPSULE**

especially suited for inexperienced or very "vivacious" talkers

**INTEGRATED SWITCHABLE LED RING**

to show system status

**GN15 M GOOSENECK MODULE**

extremely slim and rugged

**PAESP M PROGRAMMABLE POWERING MODULE**

with integrated noiseless On/Off switch

**SA60 STANDADAPTER**

securely holds the gooseneck microphone in place

**ST45 REFERENCE TABLE STAND**

for easy installation and takedown





**CK43 REFERENCE SUPERCARDIOID  
CONDENSER CAPSULE**

eliminates noise from the sides

**LIGHTRING EXPANDER**

for clear indication of the mics On/Off status from the distance

**GN30 M GOOSENECK MODULE**

perfectly aligned and easy bend in the right position

**MF M FLUSH SCHOCK MOUNT MODULE**

perfectly fits into quality designed desks

**PAE M PHANTOM POWER MODULE**

provides high immunity to radio-frequency interference

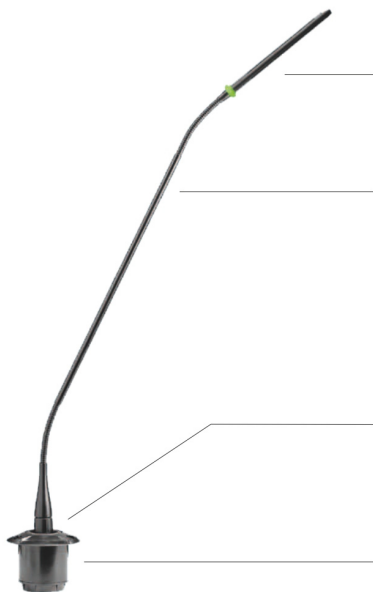

**CK49 REFERENCE SHOTGUN  
CONDENSER CAPSULE**

highly directive for picking up speech  
via greater distances

**GN50 M EXTRA LONG GOOSENECK MODULE**

with two bends for easy positioning

**H500 SHOCK MOUNT MODULE**

designed to hold long gooseneck microphones

**PAE M PHANTOM POWER MODULE**

accepts 9-52 V input for almost any available mixer inputs



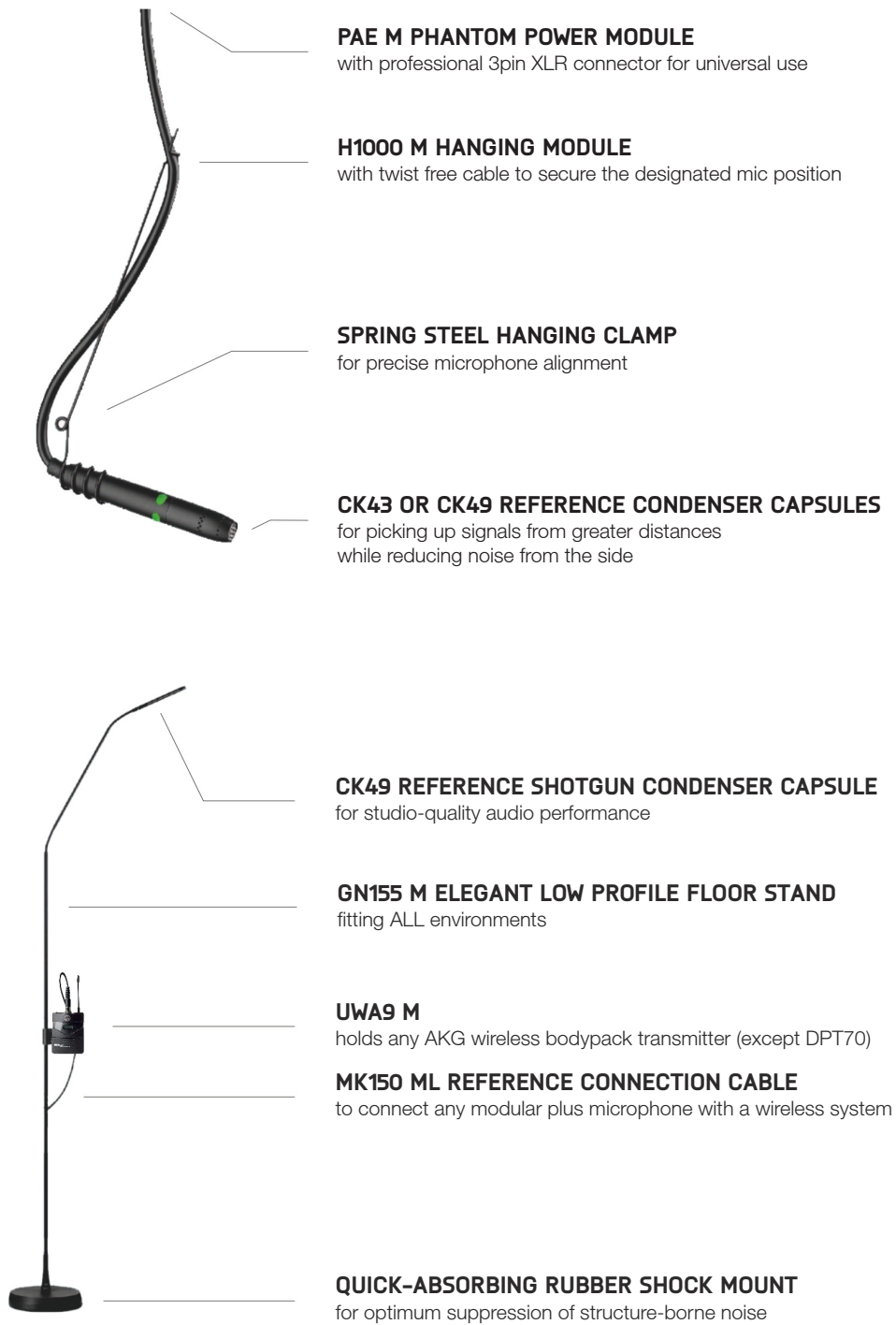

**PAE M PHANTOM POWER MODULE**  
with professional 3pin XLR connector for universal use

**H1000 M HANGING MODULE**  
with twist free cable to secure the designated mic position

**SPRING STEEL HANGING CLAMP**  
for precise microphone alignment

**CK43 OR CK49 REFERENCE CONDENSER CAPSULES**  
for picking up signals from greater distances  
while reducing noise from the side

**CK49 REFERENCE SHOTGUN CONDENSER CAPSULE**  
for studio-quality audio performance

**GN155 M ELEGANT LOW PROFILE FLOOR STAND**  
fitting ALL environments

**UWA9 M**  
holds any AKG wireless bodypack transmitter (except DPT70)

**MK150 ML REFERENCE CONNECTION CABLE**  
to connect any modular plus microphone with a wireless system

**QUICK-ABSORBING RUBBER SHOCK MOUNT**  
for optimum suppression of structure-borne noise

## 8 Dimensional Drawings

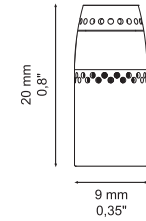
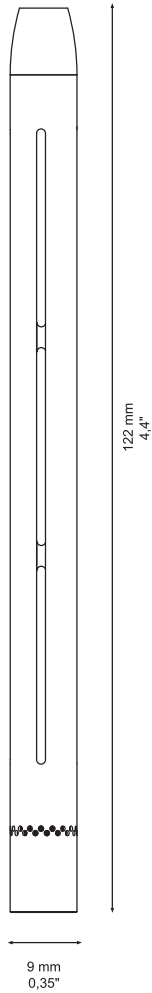

CK41/CK43

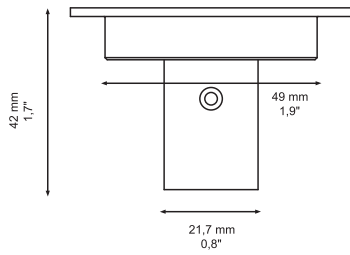

M MFM

CK49



19 mm  
0,75"

PA E M



19 mm  
0,75"

PA E5 M



19 mm  
0,75"

PA ESP M

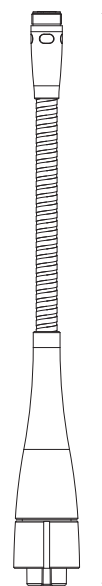

19 mm  
0,75"

GN15 M

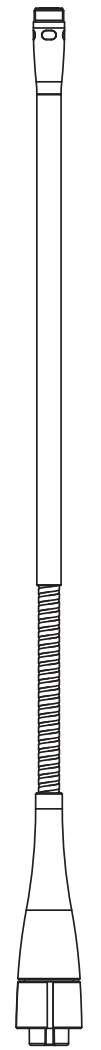

19 mm  
0,75"

GN30 M

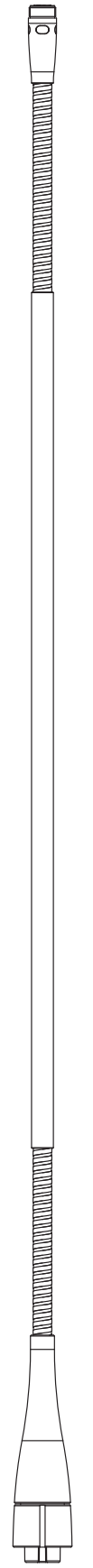

19 mm  
0,75"

GN50 M

500 mm  
19,7"



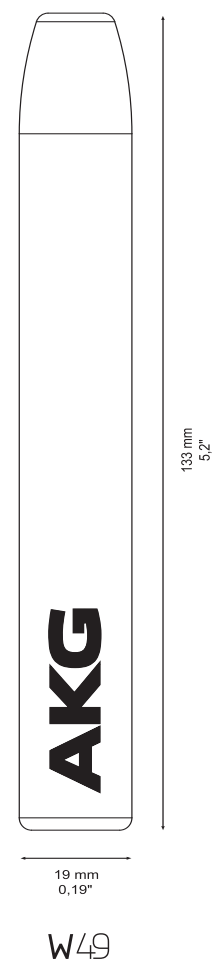
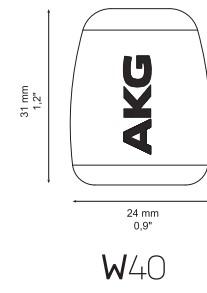
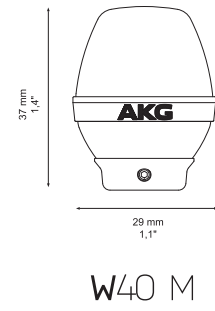
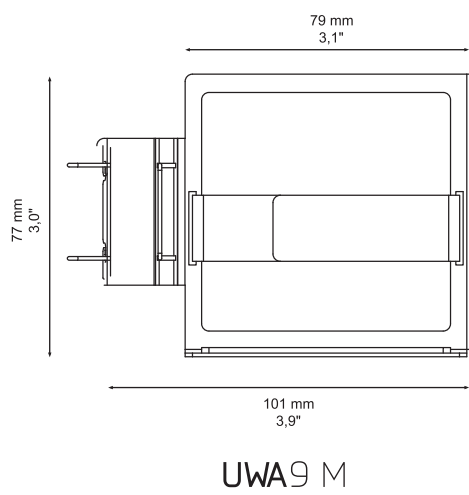
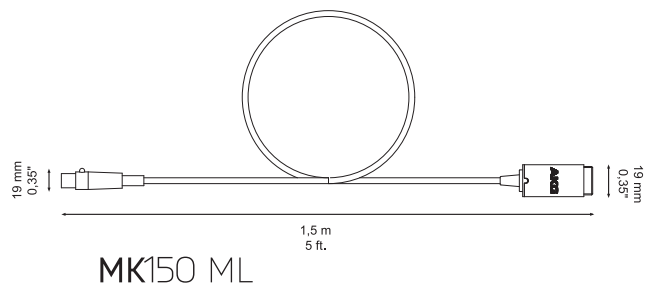
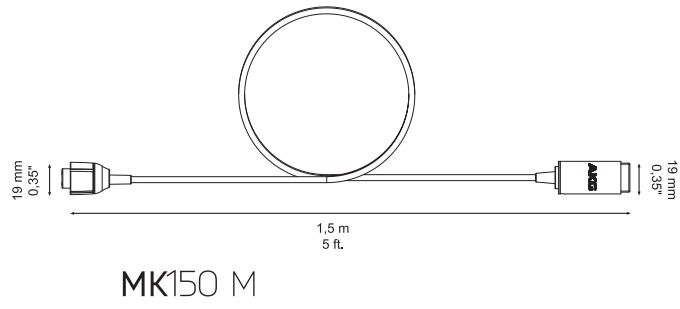
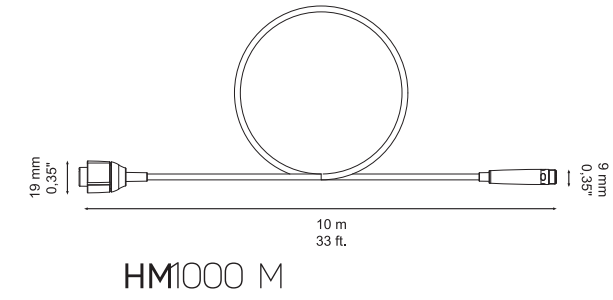
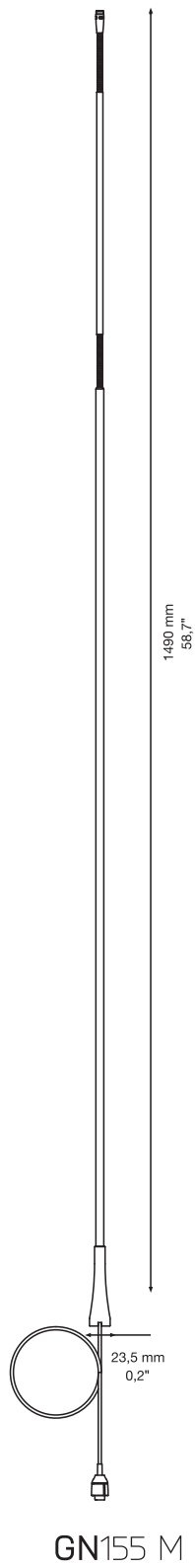

## 9 Comparison Chart

	Polar Pattern	Frequency Bandwidth (-6dB)	Sensitivity	Max. SPL for 3% THD	Equivalent Noise Level (IEC 60268-4)	Signal/Noise Ratio (A-weighted)	Diameter	Height	Finish	Net Weight
CK41	cardioid	60-22000 Hz	5 mV/Pa	142 dB	30 dB-A	64 dB-A	9 mm (0.35 in)	20 mm (0.79 in)	matte black	3,9 g (0.14 oz)
CK43	supercardioid	80-21000 Hz	5 mV/Pa	142 dB	30 dB-A	64 dB-A	9 mm (0.35 in)	20 mm (0.79 in)	matte black	3,9 g (0.14 oz)
CK49	hypercardioid	60-20000 Hz	10 mV/Pa	136 dB	30 dB-A	64 dB-A	9 mm (0.35 in)	122 mm (4.80 in)	matte black	24,5 g (0.88 oz)

	Diameter Gooseneck	Diameter Connector	Total Length	Number of flexible parts	LED Ring	Cable Length	Finish	Net Weight
GN15 M	6 mm (0.24 in)	9 mm top (0.35 in) 11,3 mm bottom (0.44 in)	165 mm (6.5 in)	1	+		matte black	77 g (2.71 oz)
GN30 M	6 mm (0.24 in)	9 mm top (0.35 in) 11,3 mm bottom (0.44 in)	300 mm (11.81 in)	1	+		matte black	94 g (3.31 oz)
GN50 M	6 mm (0.24 in)	9 mm top (0.35 in) 11,3 mm bottom (0.44 in)	500 mm (19.69 in)	2	+		matte black	114 g (4.02 oz)
GN155 M	6 mm (0.24 in)	9 mm top (0.35 in) 11,3 mm bottom (0.44 in)	1490 mm (58.66 in)	2	+	1 m (39.3 in)	matte black	4,2 kg (9.26 lbs)
HM1000 M		9 mm top (0.35 in) 11,3 mm bottom (0.44 in)	10 m (393.7 in)	cable	+	10 m (393.7 in)	matte black	184 g (6.49 oz)

	Connector Type	Contact	Programmable Switch	Bass Cut Filter	Electrical Impedance	Recommended Load Impedance	Voltage Range	Current Consumption	Diameter	Height	Net Weight
PAE M	XLR	3	-	150 Hz	< 600 Ohms	> 2000 Ohms	9-52 V	3,5 mA	19,1 mm (0.75 in)	65,5 mm (2.58 in)	43 g (1.51 oz)
PAE5 M	XLR	5	-	150 Hz	< 600 Ohms	> 2000 Ohms	9-52 V	3,5 mA	19,1 mm (0.75 in)	65,5 mm (2.58 in)	43 g (1.51 oz)
PAESP M	XLR	3	+	150 Hz	< 600 Ohms	> 2000 Ohms	9-52 V	4 mA	19,1 mm (0.75 in)	100,5 mm (3.96 in)	63 g (2.22 oz)





## 10 Notes



Mikrofone · Kopfhörer · Drahtlosmikrofone · Drahtloskopfhörer · Kopfsprechgarnituren · Akustische Komponenten  
Microphones · Headphones · Wireless Microphones · Wireless Headphones · Headsets · Electroacoustical Components  
Microphones · Casques HiFi · Microphones sans fil · Casques sans fil · Micros-casques · Composants acoustiques  
Microfoni · Cuffie HiFi · Microfoni senza filo · Cuffie senza filo · Cuffie-microfono · Componenti acustici  
Micrófonos · Auriculares · Micrófonos inalámbricos · Auriculares inalámbricos · Auriculares con micrófono · Componentes acústicos  
Microfones · Fones de ouvido · Microfones s/fios · Fones de ouvido s/fios · Microfones de cabeça · Componentes acústicos

**AKG Acoustics GmbH**

Lemböckgasse 21–25, A-1230 Vienna/AUSTRIA, phone: (+43-1) 86654-0  
e-mail: sales@akg.com

For other products and distributors worldwide visit [www.akg.com](http://www.akg.com)



Technische Änderungen vorbehalten. Specifications subject to change without notice. Ces caractéristiques sont susceptibles de modifications. Ci riserviamo il diritto di effettuare modifiche tecniche. Nos reservamos el derecho de introducir modificaciones técnicas. Especificações sujeitas a mudanças sem aviso prévio.

04/13 5014466

**AKG**<sup>®</sup>  
by HARMAN